

# NOTICE

**Note that when converting this document from its original format to a .pdf file, some minor font and format changes may occur. When viewing and printing this document, we cannot guarantee that your specific PC or printer will support all of the fonts or graphics. Therefore, when you view the document, fonts may be substituted and your individual printer may not have the capability to print the document correctly.**





**NEC**

NDA-30910  
ISSUE 1.0

***UNIVERGE SV8300***  
***DT310/DT330/DT710/DT730***

---

**USER GUIDE**

**NEC Infrontia Corporation**  
**June 2008**



## **LIABILITY DISCLAIMER**

NEC Unified Solutions, Inc. reserves the right to change the specifications, functions, or features, at any time, without notice.

NEC Unified Solutions, Inc. has prepared this document for use by its employees and customers. The information contained herein is the property of Unified Solutions, Inc. and shall not be reproduced without prior written approval from NEC Unified Solutions, Inc. All brand names and product names on this document are trademarks or registered trademarks of their respective companies.

Copyright 2008

NEC Unified Solutions, Inc.



# TABLE OF CONTENTS

---

## 1.INTRODUCTION

General .....	1
Face Layout .....	2
Keys And Parts .....	5
Icon Display .....	16
Menu List .....	17
Simple Operation by Menu Key and Cursor Key .....	17

## 2.TERMINAL SETUP

Terminal Setup With the Up/Down Key .....	19
Terminal Setup With the Feature Key.....	20

## 3.BASIC OPERATION

Login (DT700 Series Only) .....	23
Logout (DT700 Series Only) .....	23
To Originate an Outside Call .....	24
To Originate an Internal Call.....	24
Multiline Appearance .....	24
To Originate an Outside Call .....	25
To Place a Call on Exclusive Hold.....	25
To Transfer a Call.....	26

## 4.FEATURE OPERATION

To Originate a Call Using Speed Calling (One-touch Speed Calling keys) .....	27
To Originate a Call Using Speed Calling (Station/Group).....	30
To Originate a Call Using Speed Calling (System).....	30

## TABLE OF CONTENTS

---

Account Code .....	31
Forced Account Code .....	31
Authorization Code .....	31
Voice First/Tone First.....	31
Originating a Voice Call .....	32
Answer a Voice Call Hands Free.....	32
Automatic Intercom.....	32
Manual Intercom .....	33
Dial Intercom.....	33
Dial By Name Using System Speed Dialing .....	33
Dial By Name Using Station Speed Dialing .....	34
To Save a Name & Number to Station Speed Dialing .....	34
To Transfer a Call .....	35
To Place a Call on Hold .....	35
To Place a Call on Exclusive Hold.....	35
To Place a Call on Remote Hold .....	36
Conference .....	37
To Establish a Broker Call .....	37
Call Back (Station) .....	37
To Answer a Camped-On Call.....	38
To Set a Camp-On (Transfer Method).....	38
Camp-On (Call Waiting Method).....	38
Call Park (System).....	39
Call Pickup (Group) .....	39
Call Pickup (Direct) .....	39
Outside Line Queuing (From Extension Dial Tone) .....	40
Timed Queuing (Outside Line Only) .....	40
Executive Override .....	40
Last Number Redial .....	41



## TABLE OF CONTENTS

---

CID Call Back .....	41
Call Redirect .....	41
CID Call Display.....	42
Call Forwarding - All Calls .....	42
Call Forwarding - Busy .....	43
Call Forwarding - No Answer.....	43
Call Forwarding Destination.....	44
To Save and Repeat a Number .....	45
Internal Zone Paging with Meet-Me Page .....	45
Boss/Secretary Calling .....	46
Boss/Secretary Override.....	46
Do Not Disturb .....	47
Timed Reminder .....	47
Privacy Release.....	48
Return Message Schedule .....	48
Name Display .....	49
Whisper Page .....	50
System Clock Setup By Station Dialing.....	50
Day/Night Mode Change By Station Dialing .....	50
To Change Security Password .....	51
Directory Operation.....	52
History Operation.....	53
Quick Reference Guide .....	54

# TABLE OF CONTENTS

---

This Page Intentionally Left Blank

# 1. INTRODUCTION

---

## General

This guide explains how to operate DT Series (DT310/DT710/DT330/DT730) under the following headings.

### CHAPTER 1 INTRODUCTION

Explains the configuration of this guide and contains the following information.

- Face layout of DT Series
- Keys and Parts of DT Series
- Icon Display
- Menu List

### CHAPTER 2 TERMINAL SETUP

Explains the operating procedures for terminal settings of the DT Series.

### CHAPTER 3 BASIC OPERATION

Explains the basic operation of DT Series.

### CHAPTER 4 FEATURE OPERATION

Explains operating procedures for various Telephony Server features.



*DT330/DT730*

## Face Layout

**DT310/710 (2-button without LCD)**

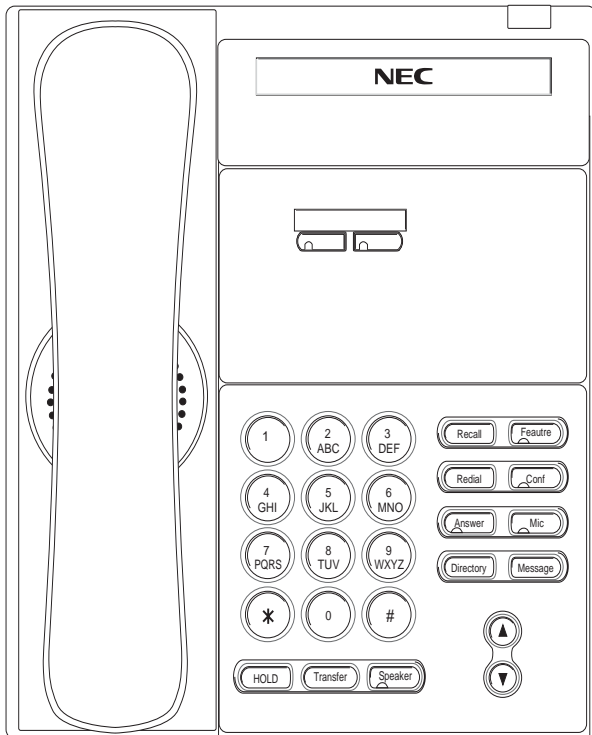

**DT310/710 (6-Button with LCD)**

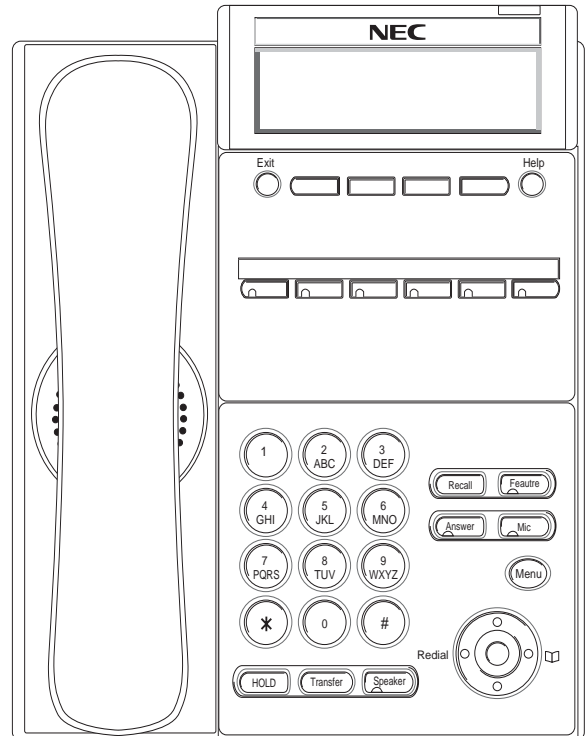

## DT330/DT730 (12-Button with LCD)

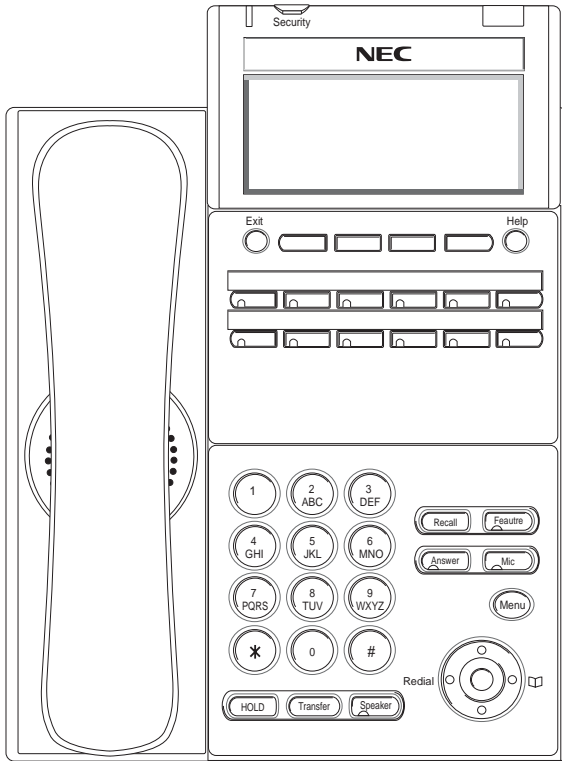

**Note:** Security button is equipped on DT730 only.

## DT330/DT730 (24-Button with LCD)

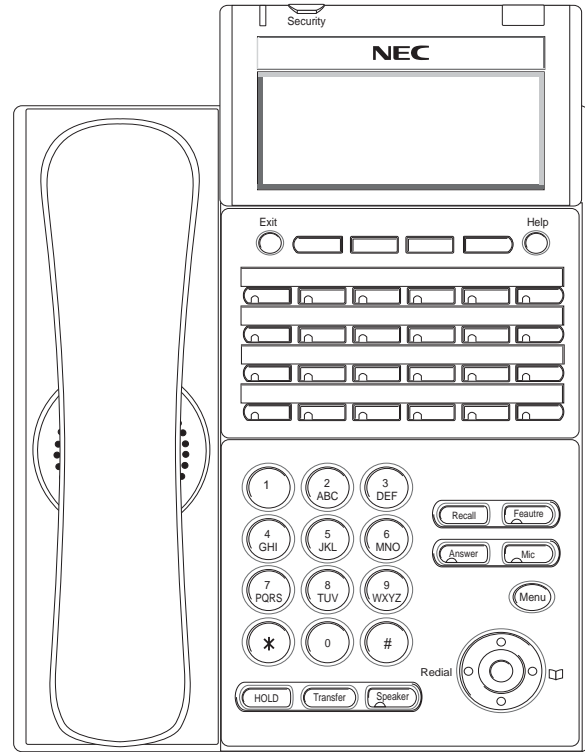

**Note:** Security button is equipped on DT730 only.

## DT330/DT730 (32-Button with LCD)

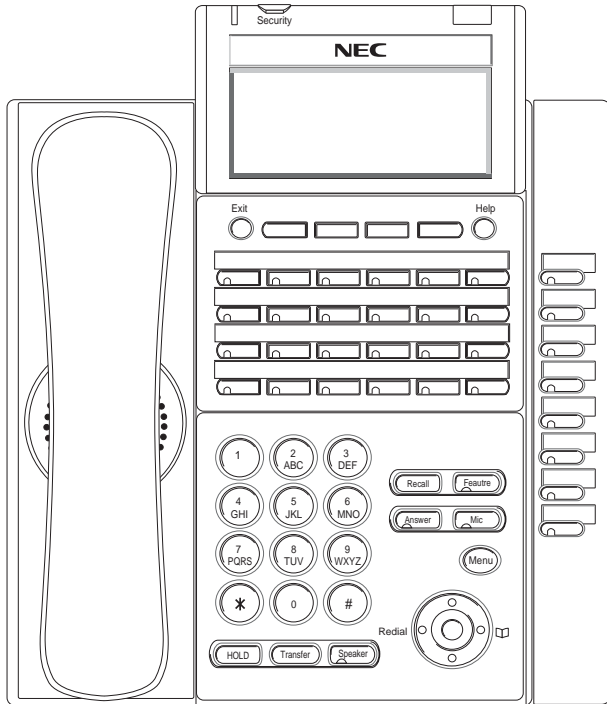

**Note:** Security button is equipped on DT730 only.

## DT330/DT730 (DESI Less 8-Button)

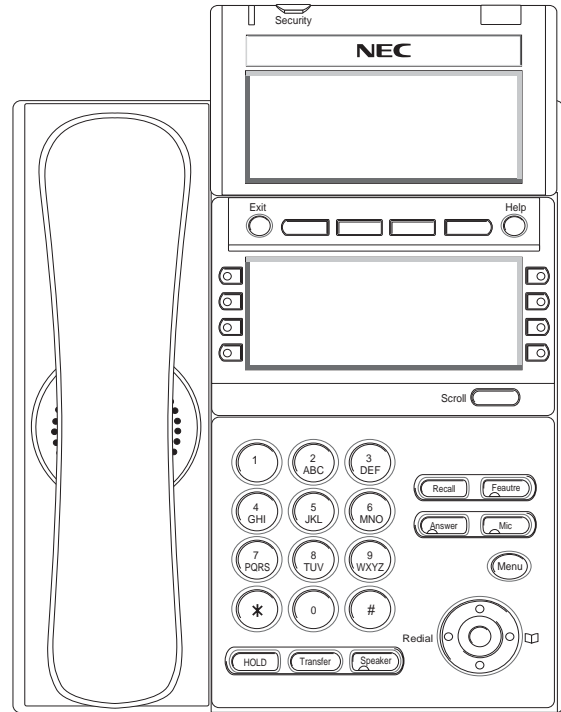

**Note:** Security button is equipped on DT730 only.

## Keys And Parts

### DT310/DT710 (2-Button without LCD)

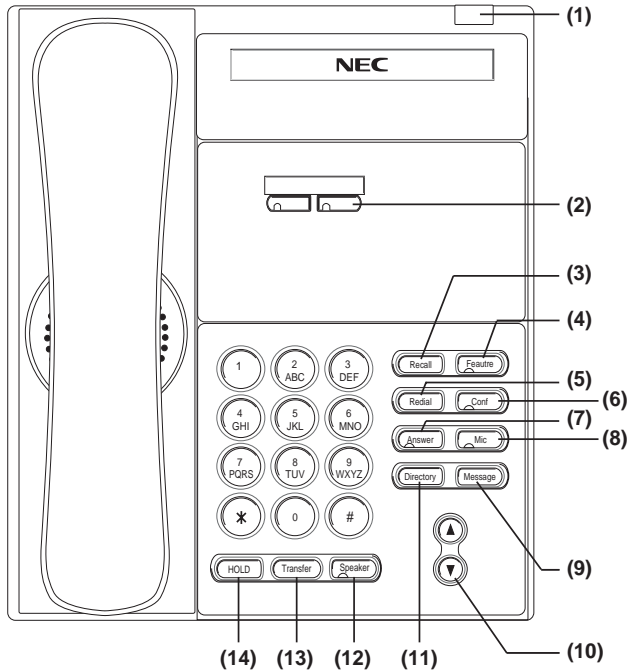

#### (1) Call Indicator Lamp

Lamp at top corner of DT Series Display flashes when a call terminates to the terminal. Lamp lights steadily when a message has been left.

#### (2) Programmable Keys

These keys can be programmed as Flexible Line key/Programmable Feature Key by Telephony Server Administrator.

When Telephony Server Administrator sets “One-Touch Speed Dial key” on the programmable keys, users can assign any numbers (ex. Telephone number, etc.) to the key (up to 24 digits).

\* For the assignment of the keys, confirm to the Telephony Server Administrator.

#### (3) Recall

Press key to finish the call and hear the dial tone.

#### (4) Feature

Used to activate any features as terminal setup functions, etc. and to program One-Touch Speed Dial Keys.

#### (5) Redial

(Last Number Call, Speed Calling-Station/Group)  
Press key to activate redial feature. Press redial and scroll back through numbers that have been dialed.

#### (6) Conf

Press key to establish a three-way conversation. LED on key lights when key is active.

#### (7) Answer

When LED on this key is lit, press key to answer a waiting call.

#### (8) Mic

Press key to respond hands free. LED on this key lights during speakerphone operation.

**(9) Message**

Press key to access the voice mail system.

**(10) Up/Down**

(∨ DOWN ^ UP)

Used to adjust LCD contrast, speaker/receiver volume, and ringer volume.

- LCD Contrast:  
Press (∨) or (^) key while idle.
- Speaker/Receiver Volume:  
Press (∨) or (^) key during conversation.
- Ringer Volume:  
Press (∨) or (^) key during ringing.

**(11) Directory**

Press key to activate speed calling - system feature.

**(12) Speaker**

Controls the built-in speaker which can be used for Hands Free dialing/monitoring.  
LED on key lights when key is active.

**(13) Transfer**

Allows the station user to transfer established calls to another station, without attendant assistance.

**(14) Hold**

Press this key to place an internal or external call on hold.



## DT330/DT730 (24-button with LCD)

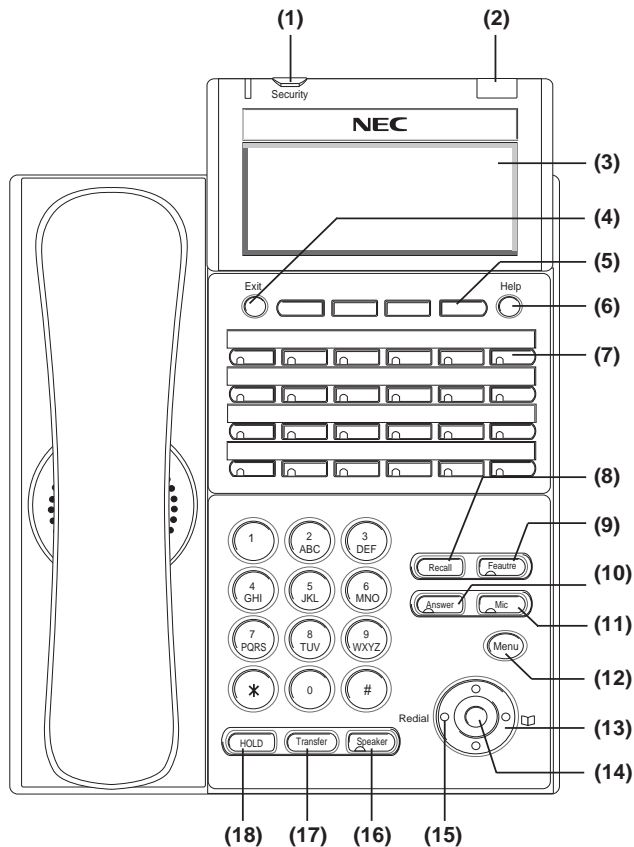

### (1) Security Button (DT730 only)

The user can prevent information leakage from terminal by simple operation.

### (2) Call Indicator Lamp

Lamp at top corner of DT Series Display flashes when a call terminates to the terminal. Lamp lights steadily when a message has been left.

### (3) LCD (Note 1)

LCD (Liquid Crystal Display) provides DT Series activity information plus data, time and Soft Key Operation.

The LCD on DT310/DT710 has 24-character, 3-line capability.

```
15:39 AM MON 18 JUL 2007
MIC VOICE >>>
```

The LCD on DT330/DT730 has 24-character, 4-line capability. Top line is used exclusively for the status icons.

```

15:39 AM MON 18 JUL 2007
MIC VOICE >>>
```

### (4) Exit

The user can exit from the Help key mode by pressing this key.

### (5) Soft Keys

Any feature shown at the bottom of the LCD is available. The appropriate feature key is displayed on the screen according to the call handling process.

### (6) Help

Explanations of the Soft Keys can be called up on the LCD by pressing this key.

### (7) Programmable Keys

These keys can be programmed as Flexible Line key/Programmable Feature Key by Telephony Server Administrator.

When Telephony Server Administrator sets "One-Touch Speed Dial key" on the programmable keys, users can assign any numbers (ex. Telephone number, etc.) to the key (up to 24 digits).

\* For the assignment of the keys, confirm to the Telephony Server Administrator.

\*\* When two telephone numbers are assigned on A side and B side of "One-Touch Speed Dial key", user can switch the side by **PAGE** key (Soft key).

### (8) Recall

Press key to finish the call and hear the dial tone.

### (9) Feature

Used to activate any features as terminal setup functions, etc. and to program One-Touch Speed Dial Keys.

### (10) Answer

When LED on this key is lit, press key to answer a waiting call.

### (11) Mic

Press key to respond hands free. LED on this key lights during speakerphone operation.

### (12) Menu

From this key, the user can access to the functions not normally used (such as terminal settings, downloads and access to XML applications) easily.

### (13) Cursor

By using this Key, DT Series user can access to various features with simple operation.

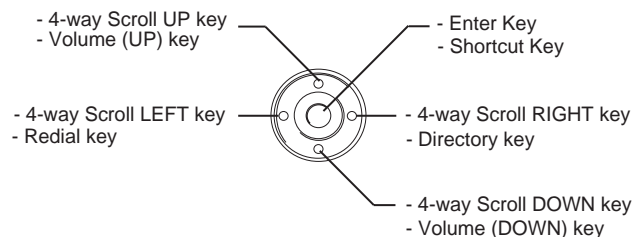

Two lines of menu items can be displayed at a time. Use "Up" or "Down" key to scroll to the item.

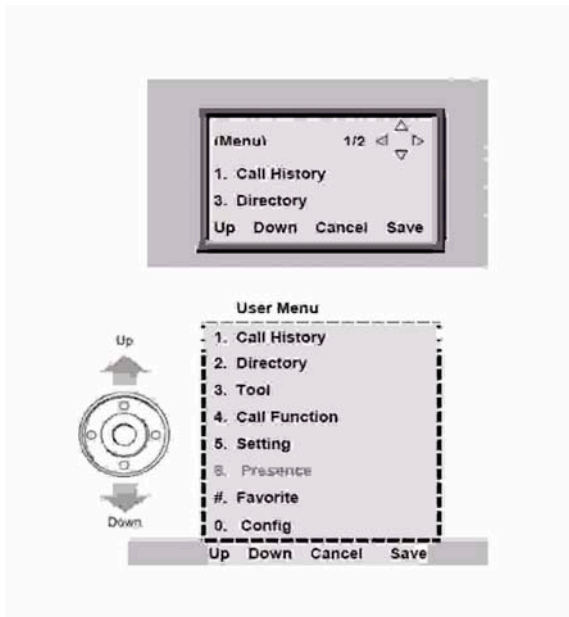

**Note:** DT310/710 (2-Button without LCD) does not have the Cursor Key.

#### (14)Enter

DT330/DT730 Series has Shortcut Menu for frequently-used features. The user can access to Shortcut Menu by pressing **Enter** Key.

**Note:** DT310/710 Series does not support the Shortcut Menu.

Shortcut Menu includes the following features.

Feature	Description
1. Missed Call	Access to history of Missed Call.
2. Voice Mail	Access to history of incoming Voice Mail.
3. IM	Not supported.
4. Presence	Not supported.
5. Bluetooth	Not supported.

**Note 2:** A-law Countries [Australia, Russia, Latin America, UK, Middle near East, other Asian nations]: #.  $\mu$ -law Countries [North America, Japan, Hong Kong, Taiwan]: \*

#### (15)Redial

(Last Number Call, Speed Calling-Station/Group)  
Press key to activate redial feature. Press redial and scroll back through numbers that have been dialed.  
When the desired number is displayed, press the \* or # (**Note 2**) key to activate dialing.

#### (16)Speaker

Controls the built-in speaker which can be used for Hands Free dialing/monitoring.  
LED on key lights when key is active.

#### (17)Transfer

Allows the station user to transfer established calls to another station, without attendant assistance.

#### (18)Hold

Press this key to place an internal or external call on hold.

**Note 1:** Not equipped on DTL-2E-1/ITL-2E-1.

## DT330/DT730 (DESI Less 8-Button with LCD)

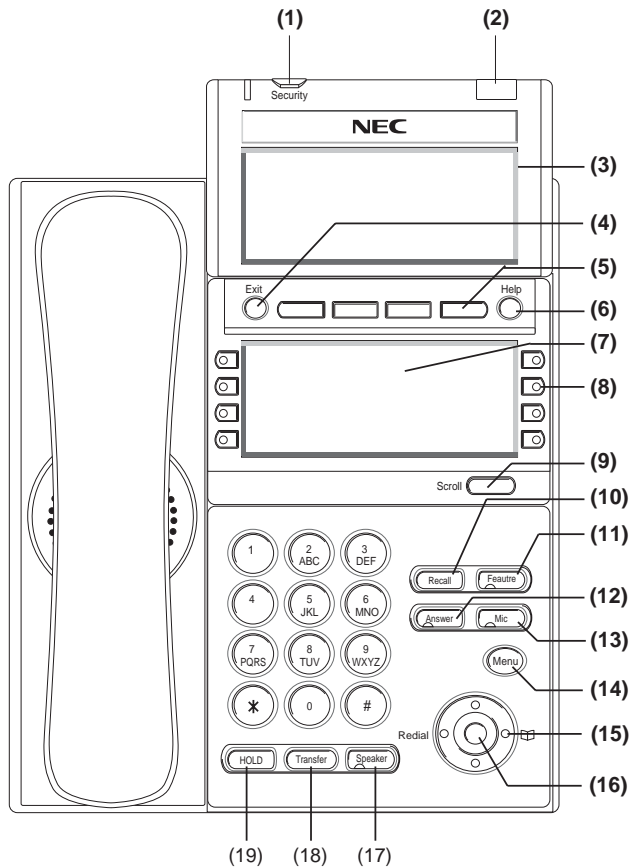

### (1) Security Button (DT730 only)

The user can prevent information leakage from terminal by simple operation.

### (2) Call Indicator Lamp

Lamp at top corner of DT Series Display flashes when a call terminates to the terminal. Lamp lights steadily when a message has been left.

### (3) LCD (Note 1)



LCD (Liquid Crystal Display) provides DT Series activity information plus data, time and Soft Key Operation.

The LCD on DT310/DT710 has 24-character, 3-line capability.

```
15:39 AM MON 18 JUL 2007
MIC VOICE >>>
```

The LCD on DT330 has 24-character, 4-line capability. Top line is used exclusively for the status icons.

```

15:39 AM MON 18 JUL 2007
MIC VOICE >>>

```

### (4) Exit

The user can exit from the Help key mode by pressing this key.

## (5) Soft Keys

Any feature shown at the bottom of the LCD is available. The appropriate feature key is displayed on the screen according to the call handling process.

## (6) Help

Explanations of the Soft Keys can be called up on the LCD by pressing this key.

## (7) 8LD Display

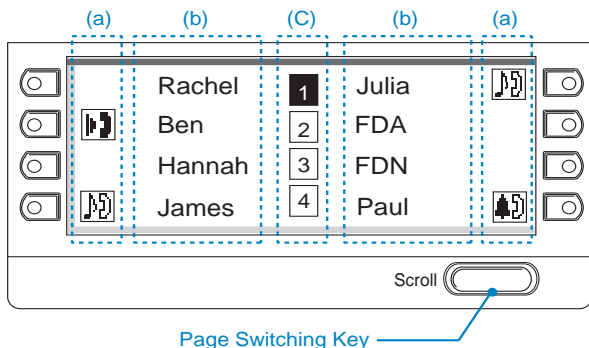

32 (8 keys x 4 pages) additional programmable keys are provided. They can be programmed as Flexible Line/Programmable feature key by Telephony Server Administrator, similar to existing programmable keys. When Telephony Server Administrator sets "One-Touch Speed Dial key" on the programmable keys, users can assign any numbers (ex. Telephone number, etc.) to the key (up to 8 digits).

\* Maximum 8 characters can be displayed.

\*\* The users can change the name displayed on the LCD. For the operating procedure, refer to **To Register Name On One-Touch Speed Dial key.**

\*\*\* For the assignment of the keys, confirm to the Telephony Server Administrator.

## (a) Icon

Status of the Line key such as Call termination, Call Hold or Busy, and setting on the Feature key are shown as Icons.

User's Status	Icon	Flashing Pattern
• Idle		
• Call Hold (Individual Hold on Call Park Group) • Exclusive Call Hold		Blink Note
• Recall (Individual Hold/Exclusive Call Hold/Call Transfer/ • Individual Hold on Call Park Group)		Blink Note
• During Conversation (Individual Use) • Call Transfer • Conference		

## (b) Feature Key Information

Feature Key Information displays the followings.

Key	Description	Maximum digits to be displayed
<b>Line Key</b>	- Name and Number information	Up to 8 digits.
<b>Feature Key</b>	- Feature Name	Up to 8 digits.
<b>One-Touch Speed Dial Key</b>	- Speed Dial Name Information - Number Information	Up to 6 digits.

## (c) Page Icon

8LD display has four pages (8 Programmable Feature keys per page). Page Icon Key indicates currently displayed page. The user can switch the Feature Key display from page 1 to 4 by using the Page Switching Key.

<b>1</b>	Feature Key 1-8	Black background indicates currently displayed page.
<b>2</b>	Feature Key 9-16	
<b>3</b>	Feature Key 17-24	Flashing indicates page with event happening.
<b>4</b>	Feature Key 17-24	

**Note 2:** *The icon flashes during events such as call termination to a line key or call back.*

Example:

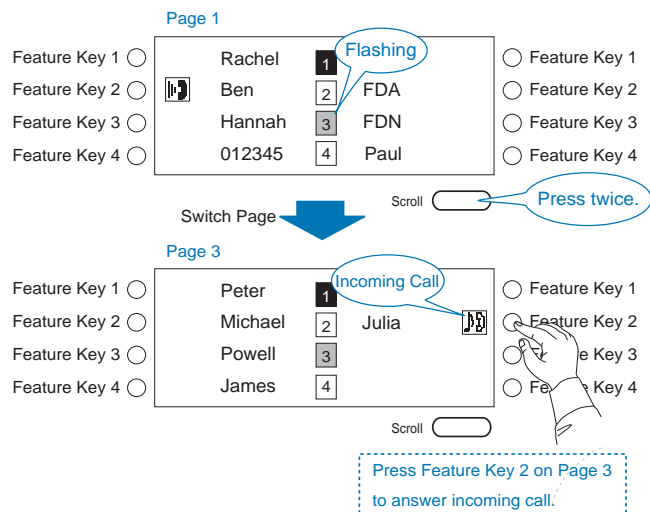

## (8) Programmable Keys

These keys can be programmed as Flexible Line key/Programmable Feature Key by Telephony Server Administrator.

When Telephony Server Administrator sets “Speed Dial key” on the programmable keys, users can assign any numbers (ex. Telephone number, etc.) to the key (up to 24 digits).

\* For the assignment of the keys, confirm to the Telephony Server Administrator.

The following picture shows LCD indication of Programmable keys.

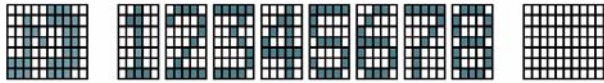

OR



Appropriate icons are displayed according to the using feature. These displays cannot be changed by user.

Following pictures shows each LCD indication when Speed Dial key is set to Programmable key. Following picture shows the indication of each status.

**When Station line/Trunk line are assigned.**

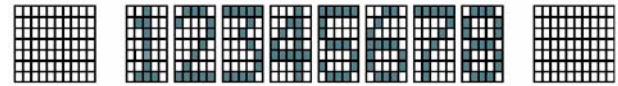

OR



No icons are displayed.

\* Users can register name on each Speed Dial key. For the procedures, refer to **To Register Name On Speed Dial key.**

**When any features using feature access code are assigned.**



Icons turn black.

\* Users can register name on each One-Touch Speed Dial key. For the procedures, refer to **To Register Name On Speed Dial key.**

#### **(9) Scroll Key**

This key is used to turn over the page of 8LD display.

#### **(10) Recall**

Press key to finish the call and hear the dial tone.

#### **(11) Feature**

Used to activate any features as terminal setup functions, etc. and to program Speed Dial Keys.

### (12) Answer

When LED on this key is lit, press key to answer a waiting call.

### (13) Mic

Press key to respond hands free. LED on this key lights during speakerphone operation.

### (14) Menu

From this key, the user can access the functions not normally used easily.

### (15) Cursor

By using this Key, DT Series user can access to various features with simple operation.

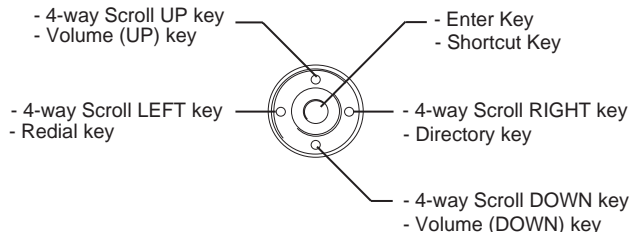

For DT330 Series, two lines of menu items can be displayed at a time. For DT730 Series, three lines of menu items can be displayed at a time. The following figure show the menu screen for DT 730 Series. Use "Up" or "Down" key to scroll the item.

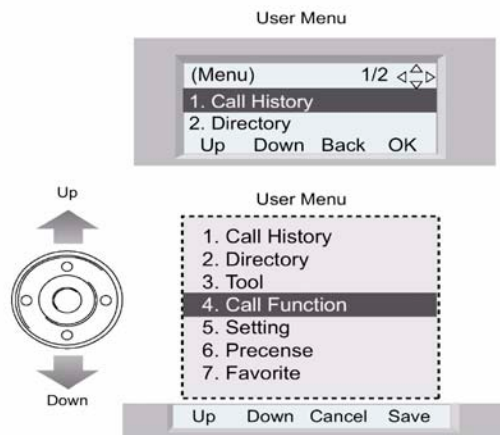

**Note:** *DT310/710 (2-Button without LCD) does not have the Cursor Key.*

### (16) Enter

DT330/DT730 Series has Shortcut Menu for frequently-used features. The user can access to Shortcut Menu by pressing **Enter** Key.

**Note:** *DT310/710 Series does not support the ShortcutMenu.*



Shortcut Menu includes the following features.

Feature	Description
1. Missed Call	Access to history of Missed Call.
2. Voice Mail	Access to history of incoming Voice Mail.
3. IM	Not Supported.
4. Presence	Not Supported.
5. Backlight	Access to screen for LCD backlight settings.
6. Bluetooth	Not Supported.

**(17)Speaker**

Controls the built-in speaker which can be used for Hands Free dialing/monitoring.

LED on key lights when key is active.

**(18)Transfer**

Allows the station user to transfer established calls to another station, without attendant assistance.

**(19)Hold**

Press this key to place an internal or external call on hold.

## Icon Display

The LCD of DT730 Series displays Desktop Icons which provide notification when events (such as missed call and voice mail) occur.

**Note:** *DT310/DT330/DT710 Series does not support the icon display.*

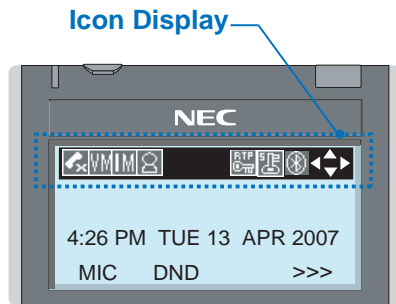

Feature	Icon	Description
Encryption		This icon appears when using RTP Encryption feature.
Security		This icon appears when the Security Key is pressed and the terminal in Security mode
Bluetooth (Note1)		This icon appears when any peripheral equipment is connected via Bluetooth.
Cursor		This icon indicates the currently available direction of the Cursor Key.

**Note 1:** *Currently unavailable.*

Feature	Icon	Description
Missed Call		This icon appears when there is a missed call. Once the user has checked the missed call, this icon will disappear.
Voice Mail		This icon provides notification of incoming Voice Mail. Once the user has checked the mail, this icon will disappear.
Instant Message (Note1)		This icon appears when the terminal receives a new instant message. Once the user has checked the message, this icon will disappear.
Presence (Note1)		This icon indicates the terminal's presence status.

## Menu List

From the Menu List, the user can use various application features such as Directory and Call History.

### To Display Menu List

- Press  Key. The Menu List is displayed in LCD. Use Cursor Key to select desired Menu Item.

N o.	Menu Item	Description
1	Call History	To view Call History.
2	Directory	To use Directory function.
3	Tool	- Uses when accessing external XML server. For details, please contact the system administrator. - Uses when sending/receiving Instant Message. ( <b>Note1</b> )
4	Call Function	Currently Not Used (grayed out).
5	Setting	To set up the terminal such as ringing volume control, LCD display setting and download of Music on Hold.
6	Presence	Currently Not Used (grayed out).
#	Favorite	By registering frequently-used features as favorite, the user can access these features with simple operation.
0	Terminal Config	This item is used for Configuration setting of DT Series.

**Note 1:** Operation for Instant Message (IM) is currently unavailable.

**Note:** Unavailable Menu items are grayed out.

## Simple Operation by Menu Key and Cursor Key

By using Menu Key and Cursor Key, DT Series user can have access to Call History, Directory and terminal settings with simple operation.

As an example, the following shows the operations how to access to Directory menu.

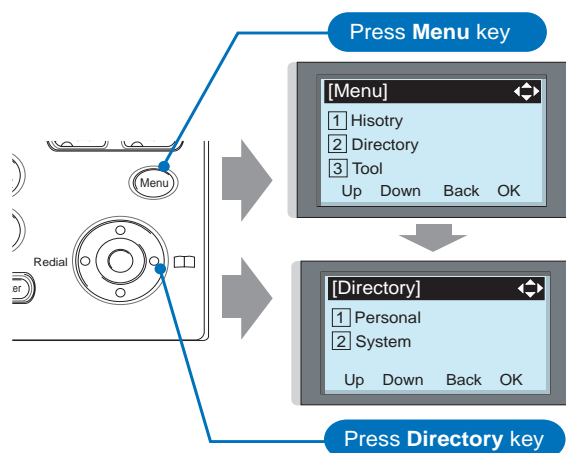

This page is for your notes.

This page is for your notes.

# 2. TERMINAL SETUP

---

This chapter describes operating procedures for terminal settings by the **UP/DOWN** Key and **Feature** Keys.

Various terminal settings such as display, sounds, password, and language are also available from **Menu** Key. For detailed information on terminal settings from Menu Key, see IP Peripheral Equipment Guide.

## Terminal Setup With the Up/Down Key

### To Adjust Handset Receiver Volume

Press the Up/Down key in the off-hook status or during the call.



### To Adjust Speaker Volume

Press the Up/Down key during speakerphone operation or during the call.

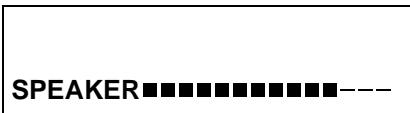

### To Adjust Ringer Tone

Press the Up/Down key during ringing.



### To Adjust LCD Contrast

Press the Up/Down key in the on-hook status.



**Note:** *When the terminal is connected with 16LD ADM, 16 degrees of LCD contrast are available (8 degrees in terminal side and 2 degrees in ADM itself). (In Expansion mode only, Link motion.)*

## Terminal Setup With the Feature Key

### Microphone On/Off

LED on Mic key shows the status of the built-in microphone.

- Press Soft Key associated with the MIC Display or press **Feature** and **1**.

### To Adjust Initial Receiving Volume

Handset receiver volume can be changed.

### To Change Handset Receiver Volume

- Press **Feature** and **2**. The LCD displays the current volume status.

4:26 PM TUE 13 APR 2008

- Press **Feature** and **2** to alternate between Large and Small volume.

4:26 PM TUE 13 APR 2008

### To Select Ringer Tone

DT Series has 10 kinds of ringer tones that you can select.

- Press **Feature** and **3**. The LCD displays the selected tone number (n=1 ~ 14).

RINGER TONE  
4:26 PM TUE 13 APR 2008

STONE No.	Frequency (Hz)	Modulation (Hz)
1	520/660	16
2	520/660	8
3	1100/1400	16
4	660/760	16
5	Melody 1	
6	Melody 2	
7	Melody 3	
8	Melody 4	
9	Melody 5	
10	Melody 6	
11	Melody 7	
12	Melody 8	
13	Melody 9	
14	Melody 10	

## To Adjust Transmission/Receiving Volume

Handset volume can be changed.

- Press **Feature** and **4**. The LCD displays the current volume.

4:26 PM TUE 13 APR 2004

- Press **Feature** and **4** again to alternate between Small and Large volume.

4:26 PM TUE 13 APR 2004

This page is for your notes.

This page is for your notes.



# 3. BASIC OPERATION

---

## Login (DT700 Series Only)

When login mode is activated, following procedure is required.

- Enter login code and press **Set** Soft key.  
(The station number is used as the Login code.)

<b>Login :</b>	<b>2000</b>
<b>Passwd :</b>	
<b>Cancel</b>	<b>BK</b>
<b>Set</b>	<b>OK</b>

- Enter the password and press **OK** Soft key.

<b>Login :</b>	<b>2000</b>
<b>Passwd :</b>	<b>*****</b>
<b>Cancel</b>	<b>BK</b>
<b>Set</b>	<b>OK</b>

- If the login code is accepted, display changes to normal idle status.

<b>15:39 AM MON 18 JUL 2007</b>
<b>MIC DND &gt;&gt;&gt;</b>

## Logout (DT700 Series Only)

- Press the preassigned **Logout** Feature Key on the terminal.

**Note:** *This location is an example.*

**Note:** *Logout button is assigned by data setting at the ECP (Enterprise Communication Platform).*

<b>15:39 AM MON 18 JUL 2007</b>
<b>MIC DND &gt;&gt;&gt;</b>

<b>15:39 AM MON 18 JUL 2007</b>
<b>L-OUT &gt;&gt;&gt;</b>

- Press the **Logout** Feature Key on the terminal again.

## To Originate an Outside Call

- Lift handset or press **Speaker** key, receive dial tone.
- Dial the Central Office access code, e.g. **9**.
- Dial desired telephone number.
- Use handset or MIC to start a conversation.  
Display indicates:

Elapsed time	Trunk type	Trunk number
<b>15:39</b>	<b>DDD</b>	<b>3</b>
<b>4:26 PM</b>	<b>TUE 13 APR 2004</b>	

## To Originate an Internal Call

- Lift handset or press **Speaker** key.
- Receive dial tone.
- Dial desired station number. Display indicates digits dialed.
- Use handset or MIC to converse.

## Multiline Appearance

### To Originate a Call

- Press the **MULTILINE APPEARANCE** feature key.
- Lift handset or press **Speaker**. Dial the Central Office access code (i.e.9).
- Dial the desired number.

### To Answer a Call

- Press the **MULTILINE APPEARANCE** feature key (ringing and flashing LED alert user to incoming call).
- Lift handset or press **Speaker**.
- Speak with incoming party.

## To Originate an Outside Call

- Press **Hold**. Held line wink flashes.

Held station  
number

<b>HOLD</b>	<b>2001</b>
<b>4:26 PM TUE 13 APR 2004</b>	

**Note:** *If held line appears on other DT Series stations, the associated LED flashes red slowly.*

## To Retrieve

- Lift handset or press **Speaker** key.
- Press held line. Use handset to converse.

**Note:** *Any station with this line appearance can retrieve the call.*

## If unanswered

- After preprogrammed time, Automatic Recall is initiated.
- Visual and audible signal (rapid flash and ring burst) is sent to station that placed call on hold.

**Note:** *Hold shows as a flashing green LED on your phone. The same line on other phones shows as a flashing red LED. Recall shows as a flashing green LED on your phone and flashing red LED on other phones with the same line.*

## To Place a Call on Exclusive Hold

- Press **Hold** twice. Line appearance indicates interrupted wink.

Held station  
number

<b>E_HOLD</b>	<b>2001</b>
<b>4:26 PM TUE 13 APR 2004</b>	

**Note:** *If held line appears on other DT Series stations, LED remains steadily lit red.*

## To Retrieve

- Lift handset or press **Speaker**.
- Press held line. Use handset to converse.

**Note:** *Only the DT Series that set Exclusive Hold option can retrieve the call.*

## If unanswered

- After preprogrammed time, Automatic Recall is initiated.
- Visual and audible signal (rapid flash and ring burst) is sent to station which placed call on Exclusive Hold. **Recall** shows as a flashing green LED on your phone, and solid red on other phones with same line.

**Note:** *Exclusive Hold excludes any other phone from picking up your held call. Exclusive Hold shows as a flashing green LED on your phone. The same line on other phones appears as a solid red LED.*

## To Transfer a Call

- After conversing, ask party to hold.
- Press **Transfer**. Receive interrupted dial tone.

4:26 PM TUE 13 APR 2004

- Dial destination station's extension, hang up or wait for answer.

Transferred station  
or trunk number

2001  
4:26 PM TUE 13 APR 2004

- If transferring party hangs up, that station's number appears in the center of recipient's display.

Transferring station

2000 DDD  
4:26 PM TUE 13 APR 2004

- The display returns to the User Setting screen.  
Press **Back** Soft Key.

# 4. FEATURE OPERATION

---

## To Originate a Call Using Speed Calling (One-touch Speed Calling keys)

- Press the desired **Speed Calling** key, or press **Speaker** and **One-Touch Speed Calling** key.

### To program

(Available only on DT Series with **Speed Calling** key.)

- Press **Feature** button.
- Press desired **One-Touch Speed Calling** key.
- Enter desired telephone number or feature access code on the keypad.  
Display indicates the digits dialed.
- Press **Feature** again to save the number.

**SET**  
**4:26 PM TUE 13 APR 2004**

### To verify

- Press **Feature** button.
- Press desired **One-Touch Speed Calling** key.
- Display indicates digits programmed.

## LCD Indication of 8LD Display

- Press the desired **One-Touch Speed Calling** key and originate a call. Registered name will be displayed as follows. For the key to which no name information is registered, the character “SPD” will be displayed.

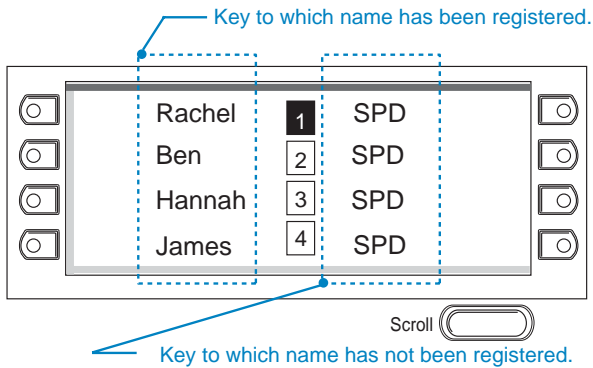

When registering Name Information of One-touch Speed Calling, the user can use uppercase alphabetic, uppercase European or lowercase European characters.

The following tables show available characters for **One-Touch Speed Calling** keys.

- **Alphabetic character (Uppercase)**

Digit Code	1	2	3	4	5	6	7	8	9	0	*	#
Character	1	A	D	G	J	M	P	T	W	0	*	#
		B	E	H	K	N	Q	U	X		@	&
		C	F	I	L	O	R	V	Y		.	(
		a	d	g	j	m	s	t	Z		,	)
		b	e	h	k	n	p	u	w		'	[
		c	f	i	l	o	q	v	x		:	]
		2	3	4	5	6	r	8	y		;	!
							s		z		-	?
						7		9		/		

- European Character (Uppercase)

Digit Code	1	2	3	4	5	6	7	8	9	0	*	#
Character	.	A	D	G	J	M	P	T	W	0	*	#
	,	B	E	H	K	N	Q	U	X			
	:	C	F	I	L	O	R	V	Y			
	!	Å	È	Ì	5	Ñ	S	Û	Z			
	?	Á	É	Í		Ö	β	Ú	9			
	-	Â	Ê	Î		Ó	7	Û				
	+	Ã	Ë	Ï		Ô		Ü				
	%	Ä	3	4		Õ		8				
	&	Å				Ö						
	/	Æ				Œ						
	(	Ç				Ø						
	)	2				6						
	=											
	ç											
i												
1												

- European Character (Lowercase)

Digit Code	1	2	3	4	5	6	7	8	9	0	*	#
Character	.	a	d	g	j	m	p	t	w	0	*	#
	,	b	e	h	k	n	q	u	x			
	:	c	f	i	l	o	r	v	y			
	!	à	è	ì	5	ñ	s	ù	z			
	?	á	é	í		ò	β	ú	9			
	-	â	ê	î		ó	7	û				
	+	ã	ë	ï		ô		ü				
	%	ä	3	4		õ		8				
	&	å				ö						
	/	æ				œ						
	(	ç				ø						
	)	2				6						
	=											
	ç											
i												
1												





## Account Code

### To enter

- Lift handset or press **Speaker**, receive dial tone.
- Enter feature access code, receive service set tone.
- Enter "Account Code" (up to 16 digits). **(Note)**
- Receive dial tone and dial desired number.

### To enter account code after authorization code

- Lift handset or press **Speaker**, receive dial tone.
- Enter feature access code for "Authorization Code", receive service set tone.
- Enter "Authorization Code", receive second service set tone.
- Enter "Account Code", receive dial tone, and dial desired number.

**Note:** *Authorization and Account Codes may be up to 20 digits combined (or 34 digits combined).*

## Forced Account Code

- Lift handset or press **Speaker**, receive dial tone.
- Enter feature access code, receive service set tone.
- Enter "Forced Account Code" (up to 10 digits), receive dial tone.

## Authorization Code

### To enter without account code

- Lift handset or press **Speaker**, receive dial tone.
- Enter feature access code, receive service set tone.
- Enter "Authorization Code" (up to 16 digits).
- Receive dial tone, dial desired number.

## Voice First/Tone First

Allows incoming station calls to your Dterm to either ring or go to voice announcement.

- Press Speaker key. Receive dial tone.
- Dial Voice/Tone access code, LED display shows current mode receives feature dial tone.

<b>VOICE</b>
<b>4:26 PM TUE 12 FEB 2008</b>

- Press \*, LED display shows mode change, receive feature set tone.

<b>TONE</b>
<b>4:26 PM TUE 12 FEB 2008</b>

**Note:** *Each time \* is pressed, you alternate between TONE and VOICE.*

## Originating a Voice Call

- Lift handset.
- Dial desired station number.
- Press **Voice** or press 1.

<b>VCL</b>	<b>2000</b>
<b>4:26 PM</b>	<b>TUE 12 APR 2008</b>

- Speak to called party.

## Answer a Voice Call Hands Free

- Receive incoming Voice Call.
- Press the **MIC** Key. LED lights.
- Respond hands-free.

**Note:** *If privacy is required, lift handset.*

## Automatic Intercom

**Note:** *Access to feature is based on data assignment.*

### To initiate

- Lift handset or press **Speaker** key.
- Press the **AICM** key.
- Tone burst is sent.

Called party

<b>ICM</b>	<b>2001</b>
<b>4:26 PM</b>	<b>TUE 12 FEB 2008</b>

### To answer

- AICM** key flashes green indicating an incoming intercom call.

Calling party

<b>ICM</b>	<b>2001</b>
<b>4:26 PM</b>	<b>TUE 12 FEB 2008</b>

- Voice Call alert tone is heard.
- Press **AICM**, lift handset or press **Speaker**. LED lights solid green.

## Manual Intercom

### To initiate

- Lift handset or press **Speaker**, press **MICM**, ringback tone is heard.

Called party

<b>ICM</b>	<b>2000</b>
<b>4:26 PM</b>	<b>TUE 12 FEB 2008</b>

- Each press of **MICM** key sends tone bursts.

### To answer

- MICM** key flashes, indicating an incoming call. Ring tone may also be heard.

Calling party

<b>ICM</b>	<b>2001</b>
<b>4:26 PM</b>	<b>TUE 12 FEB 2008</b>

- Press **MICM**.
- Lift handset or press **Speaker**, LED lights solid green.
- If called station is engaged in a non-intercom call, the station may press **MICM** after placing original caller on hold (with **Hold** key).

## Dial Intercom

### To initiate

- Lift handset or press the **Speaker** key.
- Press **DICM** key.
- Dial desired intercom station number (0-9). Tone burst is sent. (Press 1 to change to ring tone signal.)

### To answer

- DICM** LED flashes, indicating an incoming intercom call. Tone burst or ring tone is heard.
- Press **DICM**.
- Lift handset or press **Speaker**. LCD shows solid green.

## Dial By Name Using System Speed Dialing

### To initiate

- Press the **SYS** soft key.
- Enter up to the first four characters of a name using the keypad.
- Press the **UP** or **DOWN** key to start the search.
- The name and the number are shown on the LCD. If more than one name matches the letters entered, scroll through the matches with the **UP** or **DOWN** soft key.
- If no matches are found, the first System Speed Dial buffer will be displayed.
- Press the **Speaker** key, or select a **Line/Trunk** key to dial the selected number

## Dial By Name Using Station Speed Dialing

### To initiate

- Press the **Directory** key.
- Enter up to the first four characters of a name using the keypad.
- Press the **UP** or **DOWN** key to start the search.
- The name and the number are shown on the LCD. If more than one name matches the letters entered, scroll through the matches with the **UP** or **DOWN** soft key.
- If no matches are found, the first System Speed Dial buffer will be displayed.
- Press the **Speaker** key, or select a **Line/Trunk** key to dial the selected number

## To Save a Name & Number to Station Speed Dialing

### To register Name & Number

- Press the **Directory** key.
- Press the **UP** or **DOWN** key to select buffer to be programmed.
- Press the **Feature** key.  
Using the key pad enter the name.
- Press the **Feature** key.  
Using the key pad enter the number.

**Note:** *When entering an outside number you must include the Trunk access Code (i.e., 9) followed by area code and number. For a name the first 7 characters plus \* for names longer than 8 characters and the \* plus last 7 digits of a number longer than 8 digits.  
Example: Name display programmed is ABCDEFGHI button will show ABCDEFG\*.  
Number display programmed is 123456789 button will show \*3456789.*

## To Transfer a Call

- After conversing, ask party to hold.
- Press **Transfer**. Receive interrupted dial tone.

Transferred station  
or trunk number

<b>XFR</b>	<b>2001</b>
<b>4:26 PM TUE 12 FEB 2008</b>	

- Dial destination station's extension, hang up or wait for answer.

## To Place a Call on Hold

- Press the **HOLD** key. Held line wink flashes.

Held station  
number

<b>HLD</b>	<b>2001</b>
<b>4:26 PM TUE 12 FEB 2008</b>	

**Note:** *If held line appears on other stations, the associated LED flashes red slowly.*

### To Retrieve:

- Lift handset or press Speaker key.
- Press held line. User handset to converse.

**Note:** *Any station with this line appearance can retrieve the call.*

## If Unanswered:

- After preprogrammed time, Automatic Recall is initiated.
- Visual and audible signal (rapid flash and ring burst) is sent to station that placed call on hold.

**Note:** *Hold shows as a flashing green LED on your phone. The same line on other phones shows as flashing red LED. Recall shows as a flashing green LED on your phone and flashing red LED on other phones with the same line.*

## To Place a Call on Exclusive Hold

### To Initiate:

- Press the **HOLD** key twice. Line appearance indicates interrupted wink.

Held station  
number

<b>EHD</b>	<b>2001</b>
<b>4:26 PM TUE 12 FEB 2008</b>	

**Note:** *If held line appears on other stations, LED remains steadily lit red.*

### To Retrieve:

- Lift handset or press **Speaker** key.
- Press held line. User handset to converse.

**Note:** *Only phone that set Exclusive Hold option can retrieve the call.*

### If Unanswered:

- After preprogrammed time, Automatic Recall is initiated.
- Visual and audible signal (rapid flash and ring burst) is sent to station that placed call on hold. Recall shows as a flashing green LED on your phone, and solid red on other phones with same line.

**Note:** *Exclusive Hold excludes any other phone from picking up your held call. Exclusive Hold shows as a flashing green LED on your phone. the same line on other phones appears as a solid red LED.*

## To Place a Call on Remote Hold

### To Initiate:

*While in conversation with Station/Trunk Party*

- Press the **Transfer** key. Receive interrupted dial tone.
- Dial destination station's extension.
- Receive ring back tone.
- Press the **Hold** key. (Call is placed on hold at the destinations station's extension)
- Hang up.

### To Retrieve At Destination:

- Lift handset or press **Speaker** key.
- Press line on hold. User handset to converse.

**Note:** *Any station with the destination line appearance can retrieve the call.*

### To Retrieve From Phone Without Destination Line Appearance:

- Lift handset or press **Speaker** key.
- Dial Access Code for Direct Call Pick-Up.
- Dial destination station's extension.
- Use handset to converse.

## Conference

### Option 1

- With call in progress, ask party to hold.
- Press **Transfer**, receive interrupted dial tone.
- Dial desired number.
- After call is answered, press **Conf** key. **Conf** LED lights.
- Three-way conference is established.

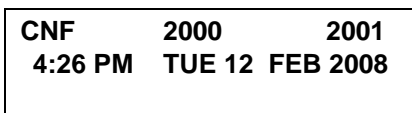

- If one party hangs up, other two remain connected. **Conf** LED goes out.

### Option 2

- With call in progress and third party on hold on another Line/Trunk key.
- Press **Conf** key, **Conf** LED flashes.
- Press Held Line/Trunk key, **Conf** LED lights.
- Three-way conference is established.

**Note:** *Access to Option 2 is based on software revision and data assignment.*

## To Establish a Broker Call

- While engaged in a call and wishing to consult a third party, press **Transfer**. Caller is automatically placed on hold.
- Dial desired party to consult.
- Press **Transfer** to return to original caller. Third party is automatically placed on hold.
- By repeating these steps, it is possible to alternate between calls.

**Note:** *The display indicates connected station or trunk at any given time.*

## Call Back (Station)

- Lift handset or press **Speaker**.
- Dial desired station number and receive busy tone or ring back tone.
- Press **Call Back** or dial **2** and receive service set tone.
- Restore handset.
- When busy station becomes idle or the station that did not answer initiates or answers a call or accesses a feature and then becomes idle, the setting station is alerted by ring and flashing LED.

## To Answer a Camped-On Call

- While engaged in a call, receive the camp-on indication (one short tone burst). **Answer** LED flashes.

Outside Line	Outside Line	
Type	Number	
<b>CMP</b>	<b>WATS</b>	<b>3</b>
<b>4:26 PM</b>	<b>TUE 12 FEB 2008</b>	

- Press **Answer** key. Call in progress is placed on hold.
- Connection to camped-on call is established.
- Press **Answer** to return to original call. Camped-on call is placed on hold.
- Repeating depression of the **Answer** key allows you to alternate between calls. Display indicates connected station or trunk at any given time.

## To Set a Camp-On (Transfer Method)

- With call in progress, ask party to hold. Depress **Transfer** button, feature dial tone is heard.
- Dial desired station number and receive busy tone.
- Dial **4** and receive service set tone. Camp-on tone (2 tone bursts) is sent to busy station.
- Restore handset.

## Camp-On (Call Waiting Method)

*Example: Station 2000 is in conversation with 2008. Station 2001 dials 2000, receives busy. Station 2001 can notify station2000 that call is waiting.*

### To Activate Call Waiting (Station 2001)

- Station 2001 press **Speaker**. Receive dial tone.
- Dial 2000 and receive busy.

Outside Line	Outside Line	
Type	Number	
<b>BUSY</b>	<b>2000</b>	
<b>4:26 PM</b>	<b>TUE 12 FEB 2008</b>	

- Press **Transfer** key and receive feature dial tone.
- Dial Camp-on (call waiting) access code.

### To Answer Call Waiting (Station 2000)

- Hear burst of tone. LCD display indicates CW and Answer button flashes.

	Called station number	
<b>CW SET</b>	<b>2000</b>	
<b>4:26 PM</b>	<b>TUE 12 FEB 2008</b>	

- 2000 presses Answer button and converses with station 2001.



<b>CW</b>	<b>2001</b>
<b>4:26 PM TUE 12 FEB 2008</b>	

**Note:** Station 2000 can alternate between the two parties by pressing Answer button.

## Call Park (System)

### To Park A Call From Terminal With LCD

- While connected to a station or trunk, press Transfer key and dial the **Call Park** access code, or press Call Park key. Display shows HLD=(park location number nn=00-19)

	Parked station or trunk
<b>HLD=nn</b>	<b>2000</b>
<b>4:26 PM TUE 12 FEB 2008</b>	

### To Park A Call From Terminal Without LCD

- While call in progress, press **Transfer** key and dial the Call Park access code, or press Call Park key.
- Dial Call Park location number (00-19) and receive service set tone. (If park location is busy, dial the next location number.)
- Restore handset.

### To Retrieve A Parked Call

- Dial Call Park local retrieval code and parked call location number (00-19).
- Station users connected to parked call.

## Call Pickup (Group)

### When Station Within Pickup Group Rings

- Lift handset.
- Press **Call Pickup** key or dial Call Pickup access code (may be stored on-one-touch speed calling key).

	Called station	Calling party
<b>PCK</b>	<b>2000</b>	<b>2001</b>
<b>4:26 PM</b>	<b>TUE 12</b>	<b>FEB 2008</b>

- Connection to calling party is established.

## Call Pickup (Direct)

- Lift handset.
- Press Call Pickup Direct key or dial Call Pickup Direct access code (may be stored on one-touch key).

	Called station	Calling party
<b>PCK</b>	<b>2000</b>	<b>2001</b>
<b>4:26 PM</b>	<b>TUE 12</b>	<b>FEB 2008</b>

- Dial extension number to be picked up.
- Connection to calling party is established.

## Outside Line Queuing (From Extension Dial Tone)

### If Outside Line is Busy

- Press **Speaker** key or lift handset dial outgoing access code (e.g., 9).
- Press Call Pickup Direct key or dial Call Pickup Direct access code (may be stored on one-touch key).

<b>SET</b> <b>4:26 PM TUE 12 FEB 2008</b>
--

- Receive a Busy indication. Press **Call Back** key. Call is placed in queue for next available Outside Line.
- Replace handset.
- When Outside Line is available, setting station is alerted by ringing and flashing red LED.
- Press **Speaker** key or lift handset. Dial tone is heard. Dial desired number. (No outgoing access code needed.)

## Timed Queuing (Outside Line Only)

- Press **Speaker** key, receive dial tone.
- Dial **Outside Line** access code and desired number.
- Receive busy tone or ring no answer from distant end.
- Press **Call Back** key, LED flashes, leave speaker on.
- The desired number is automatically redialed.
- Pick up handset and converse.

**Note:** *When station is in Timed Queue mode callers receive busy indication.*

## Executive Override

### If Called Station is Busy

- Press **Override** key and converse.

Override  
station Overridden

<b>OVR</b>	<b>2000</b>	<b>2001</b>
<b>4:26 PM</b>	<b>TUE 12</b>	<b>FEB 2008</b>

**Note:** *Interrupted parties receive a waning tone.*

## Last Number Redial

### To Recall the Last Number Dialed

- Press **Redial**. Receive special dial tone.

REDIAL[#]/SPEED[ ]	-1
	2001

Last number dialed

- Press **#**. The number dialed will be redialed and displayed.

REDIAL[#]/SPEED[ ]	-1
	2001

Last number dialed

**Note:** *Each time the Redial key is pressed the numbers dialed for the last five calls are displayed sequentially.*

## CID Call Back

### To Search, Call Back, or Erase A Calling Number Using Soft-keys.

- Lift the handset or press **Speaker** key.
- Press **Message** key.
- Press **Search** soft key to search for desired number.
- Press **CB** soft key to call back desired number.
- Press **Erase** soft key to erase desired number.

### To Search, Call Back, or Erase A Calling Number Without Using Soft-keys.

- Lift the handset or press **Speaker** key.
- Press **Message** key.
- Dial **1** to search for desired number.
- Dial **2** to call back desired number.
- Dial **3** to erase desired number.

## Call Redirect

### To Redirect With Calling Party Information.

- While in the CID mode press **CRD** key.
- Call is transferred to a pre-assigned destination station.

### To Redirect Without Calling Party Information.

- Press **CRD** key.
- Press incoming line key or line key on hold.
- Call is transferred to a pre-assigned destination station.

**Note:** *See CID Display; Access to feature is based on data assignment.*

## CID Call Display

### To Display Calling Party Information:

- Press **CID** key, CID lamp lights.
- Calling Party information is displayed.

### To Redisplay Calling Party Information:

- While on a call press **CID** key to recall the Calling Party Information.
- Calling Party information is displayed.

## Call Forwarding - All Calls

### To Set

- Press **Speaker** key. Receive dial tone.
- Press **FD-A** key or dial Call Forward-All access code. Receive special dial tone.
- Dial destination station or outside telephone number. Receive service set tone
- FD-A** LED lights (at your station if FD-A key was used).
- Press **Speaker** key. Call Forwarding for all calls is set.

Forwarding  
station

<b>FWD</b>	<b>2000</b>
<b>4:26 PM</b>	<b>TUE 12 FEB 2008</b>

### To Verify (With Multi-line Phone)

- Press **Speaker** key. Receive extension dial tone.
- Press **FD-A** key or dial Call Forward-All access code.
- Display indicates the station number calls are forwarded to.

<b>FWD</b>	<b>2000</b>
<b>4:26 PM</b>	<b>TUE 12 FEB 2008</b>

### To Cancel

- Press **Speaker** key. Receive dial tone.

<b>CNCL</b>	
<b>4:26 PM</b>	<b>TUE 12 FEB 2008</b>

- Press **FD-A** key plus \* or dial Call Forward - All cancel code. Receive service set tone. LED goes out at your station (or the phone of the sub line station).
- Press **Speaker** key.

## Call Forwarding - Busy

### To Set

- Press **Speaker**. Receive dial tone.
- Press **FDB** key or dial Call Forward Busy access code. Receive special dial tone.
- Dial destination station or external telephone number. Receive service set tone.
- FD-B** LED lights (at your station or at the phone of the sub line station you are setting).
- Press **Speaker**. Call Forward Busy is set.

<b>SET</b>	<b>2000</b>
<b>4:26 PM</b>	<b>TUE 12 FEB 2008</b>

### To Verify (with Display Phone)

- Press **Speaker** key. Receive dial tone.
- Press **FD-B** or dial Call Forward Busy access code.
- Display indicates the station number calls are forwarded to.

Destination station

<b>SET</b>	<b>2000</b>
<b>4:26 PM</b>	<b>TUE 12 FEB 2008</b>

### To Cancel

- Press **Speaker**. Receive dial tone.
- Press **FD-B** key plus \* or dial Call Forward Busy cancel code. Receive service set tone. LED goes out at your station.

<b>CNCL</b>	<b>2000</b>
<b>4:26 PM</b>	<b>TUE 12 FEB 2008</b>

- Press **Speaker**. Call Forwarding is cancelled.

## Call Forwarding - No Answer

### To Set

- Press **Speaker**. Receive dial tone.
- Press **FD-N** or dial Call Forward No Answer access code. Receive special dial tone.
- Dial destination station or external telephone number. Receive service set tone.
- FD-N** LED lights (at your station if FD-N key was used).
- Press **Speaker** key. Call Forward No Answer is set.

<b>SET</b>	<b>2000</b>
<b>4:26 PM</b>	<b>TUE 12 FEB 2008</b>

## To Verify

- Press **Speaker** key. Receive extension dial tone.
- Press **FD-N** key or dial Call Forward No Answer access code.
- Display indicates destination number of call forward.

Forwarding  
station

<b>FWD</b>	<b>2000</b>
<b>4:26 PM</b>	<b>TUE 12 FEB 2008</b>

**Note:** *Call Forwarding for Busy Line and No Answer may be combined depending upon system programming.*

## Call Forwarding Destination

### To Set

- Press **Speaker** key. Receive dial tone.
- Press **FD-DS** key or dial Call Forward Destination access code. Receive special dial tone.

<b>SET</b>	<b>2000</b>
<b>4:26 PM</b>	<b>TUE 12 FEB 2008</b>

- Dial station number to be forwarded to this line. Wait for service set tone.

### To Cancel

- Press **Speaker**. Receive dial tone.
- Press **FD-DC** key or dial Call Forward Destination cancel code.

<b>CNCL</b>	
<b>4:26 PM</b>	<b>TUE 12 FEB 2008</b>

- Dial station number to cancel.
- Press **Speaker** key. Call Forward Destination is cancelled.

## To Save and Repeat a Number

### To Save

- Press **Speaker**.key.
- Dial desired telephone number.
- Press **S&R** key. Dialed number is now stored. **S&R** LED lights.

### To Repeat

- Press **Speaker**.
- Press **S&R** key. Phone automatically redials the programmed number.
- S&R** automatically canceled. LED goes out.

**Note:** *If saved number is busy or no answer is received, to save it again, press **S&R** key again before hanging up.*

## Internal Zone Paging with Meet-Me Page

This allows a system user to page over built-in speaker or multi-line phone within the assigned zone or all zones.

**Example:** Station A can page Station B. When Station B dials answer code, they are connected.

### To Page (Station A)

- Lift Handset. Receive dial tone.
- Dial Internal Paging access code for desired zone or all zones or press key assigned for desired zone or all zones.

**PAGING**  
**4:26 PM TUE 12 FEB 2008**

- Page station B.
- Remain off hook.

### To Answer (Station B)

- Station B dials Meet-Me answer code, and they are immediately connected.

Paging  
station

**2000**  
**4:26 PM TUE 12 FEB 2008**

**Note:** *Access to this feature is based on data assignment.*

## Boss/Secretary Calling

### Secretary

- Lift handset, press boss' ringing line. Ask calling party to hold.

Calling party

<b>2001</b>
<b>4:26 PM TUE 12 FEB 2008</b>

- Press boss' line again. Voice Call is automatically established to boss' extension.
- Announce the call to the boss.

### If Boss Accepts Call

- Secretary replaces handset.

Boss and secretary station each  
display the other's number

<b>2000</b>
<b>4:26 PM TUE 12 FEB 2008</b>

- Boss lifts handset, presses flashing line.

### If Boss Refuses Call

- Secretary presses **Transfer** key to return to calling party.

**Note:** *Access to this feature is based on data assignment.*

## Boss/Secretary Override

*Example: Station 2000 is boss, Station 2001 is secretary. Boss is connected to 2003. Incoming call on outside line connects to secretary, but is intended for boss.*

### Secretary

- Lift handset to answer Outside line, ask caller to hold.

Boss' station  
number

<b>CW</b>	<b>2000</b>
<b>4:26 PM</b>	<b>TUE 12 FEB 2008</b>

- Press Boss' line. Outside line is placed on hold; Boss hears burst of tone and Boss' **Answer** key flashes.

### Boss

- Hears bursts of tone, Answer key flashes. LCD display indicates:

Secretary's station  
number

<b>CW</b>	<b>2001</b>
<b>4:26 PM</b>	<b>TUE 12 FEB 2008</b>



### Option 1

- Boss presses **Answer** and converses with secretary. Outside line is placed on hold.
- Secretary hangs up. Boss is connected to Outside line.
- Boss can alternate between the two parties by pressing **Answer**.

### Option 2

- Boss does not respond to burst of tone, secretary presses **Transfer** key.
- Secretary is connected to the Outside line.

### Option 3

- Boss presses **Answer** and converses with Secretary. Outside line is placed on hold.
- Secretary is returned to Outside line.
- Boss can alternate between the two parties by pressing **Answer**.

## Do Not Disturb

- Press **Speaker** key, Receive dial tone.
- Press **DND** key or dial DND access code.

**SET**  
4:26 PM TUE 12 FEB 2008

### To Cancel

- Press **Speaker key, Receive dial tone**.
- Press **DND** key or dial DND cancel code.

**CNCL**  
4:26 PM TUE 12 FEB 2008

**Note:** When key is used the LED will light when DND is active.

## Timed Reminder

Example: Station 2000 wants to be reminded of a 9:00 a.m. meeting.

### To Set

- Press Speaker key.

**SET** **0900**  
4:26 PM TUE 12 FEB 2008

## Privacy Release

Example: DTerm Station B is engaged in a conversation, and allows DTerm Station A to enter the call in progress.

- Station 2000, while engaged in conversations, presses **Conf** key. **Conf** key flashes.
- Station 2001 lifts handset or presses **Speaker** key.
- Station 2001 presses the line appearance of Station 2000.
- A three-way conference is established.

## Return Message Schedule

**Note:** *With Display phone, this feature allows station user to register a return schedule when leaving the office and have the schedule display on the calling phone LCD.*

### To Set

- Station Speaker. Receive dial tone.
- Dial Return Schedule access code.
- Dial the number corresponding to desired message.

Dial	Message	
0	IN:BACK	HH:MM
1	OUT:BACK	HH:MM
2	AWAY:BACK	MM:DD
3	VACATION	MM:DD

- If 0 or 1: dial desired military time.

<b>IN:BACK</b>	<b>0900</b>
<b>4:26 PM</b>	<b>TUE 12 FEB 2008</b>

- If 2 or 3: dial month and day.  
Example: June 24=0624.

<b>AWAY:BACK</b>	<b>0900</b>
<b>4:26 PM</b>	<b>TUE 12 FEB 2008</b>

- Receive dial tone.
- Press **Speaker** key.

### To Cancel

- Press **Speaker** key, receive dial tone.
- Dial Return message schedule cancel code.

<b>CNCL</b>	
<b>4:26 PM</b>	<b>TUE 12 FEB 2008</b>

- Receive set tone.
- Press **Speaker** key.

**Note:** *Access to feature is based on data assignment.*

## Name Display

**Note:** *Requires Display Phone*

A name with up to 16 characters can be entered to display the name on other Dterm telephones when making a call.

- Press **Speaker** key. Receive set tone.
- Dial the Name Assignment access code and receive special dial tone.
- Using the keypad, depress the key with the desired letter to display the first letter on the key. The display will indicate the numerical designation. Subsequent depressions will advance through the letters on that key. The Dial Pad Key Table below can be used as a guide to indicate the key and the number of depressions required to display, letters, spaces and periods.

DIAL PAD KEY												
	1	2	3	4	5	6	7	8	9	0	*	#
1	1	3	3	4	5	6	7	8	9	0	*	#
2	.	A	D	G	J	M	P	T	W		*	#
3	.	B	E	H	K	N	Q	U	X		*	#
4	.	C	F	I	L	O	R	V	Y		*	#
5	.						S	Z			*	#

- When the desired letter is displayed, depression of the Transfer key will change the letter to a lower case letter (default is upper case). Depress the Hold key to enter that letter and advance to the next entry.

- Repeat the previous two steps until the desired name is displayed and entered.
- Press Speaker key.

For example, to enter "Paul".

7	7	HOLD	2	2	TRF	HOLD
8	8	8	TRF	HOLD		
5	5	5	5	TRF	HOLD	

**Note:** *When adding/changing/deleting name display for an extension that appears on a key of a 16LD phone a reset of the 16 LD phone is required and can be accomplished by an unplug/plug-in of the phone. For the 16LD phone using one of the line keys as speed dial will only display 8 characters; For a name the first 7 characters plus \* for names longer than 8 characters and the \* plus last 7 digits of a number longer than 8 digits.*

**Example:** name display programmed is ABCDEFGHI button will show ABCDEFG\*. Number display programmed is 123456789 button will show \*3456789.

## Whisper Page

### To Initiate

#### Option 1

- Lift handset or press **Speaker** key.
- Dial desired station number.
- Receive Busy Tone press **Transfer** key.
- Dial Whisper Page access code or press Whisper Page Feature Key.
- Tone is heard, Listen to conversation and speak to station only.

#### Option 2

- Lift handset or press **Speaker** key.
- Dial Whisper Page access code or press Whisper Page Feature Key.
- Receive Feature dial tone.
- Dial desired station number.
- Tone is heard, Listen to conversation and speak to station only.

### To Answer

- Press **Answer** key. Call in progress is placed on hold.
- Hold tone source is not transmitted and to the original party.
- Calling station and called station can privately speak.
- Press Answer key to return to original call.

**Note:** Access to feature is based on data assignment.

## System Clock Setup By Station Dialing

- Press **Speaker** key or lift handset. Receive dial tone.
- Press **System Clock Setup** key or feature access code.
- Dial new time in 24 hr. format using 6 digits (HHMMSS).
- Receive service set tone, replace handset or press **Speaker** key.

**Note:** Access to feature is based on data assignment.

## Day/Night Mode Change By Station Dialing

- Press **Speaker** key or lift handset. Receive dial tone.
- Press Day/Night Mode key or feature access code.
- Dial 1 for Day/2 for Night/3 for Mode-a or 4 for Mode-B.
- Replace handset or press **Speaker** key.

**Note:** Access to feature is based on data assignment.  
If a key is used lamp indication will be:  
Night Mode = Red lamp on  
Mode-A = Red lamp flashing (60 ipm)  
Mode-B = Red lamp flashing (120 ipm)

## To Change Security Password

- Press Menu Key
- Display reads:

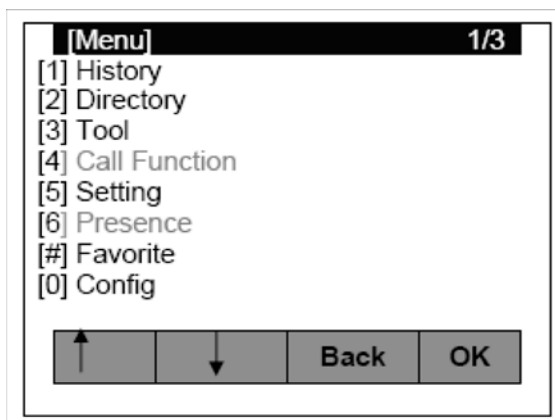

- Using Up/Down arrows scroll down to [5]
- Press [5] for setting, then **OK**

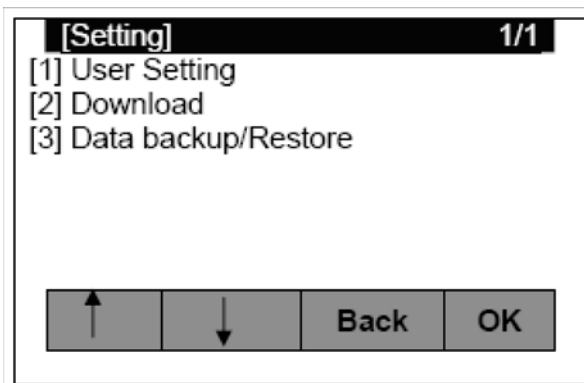

- Press [1] for User Setting, then **OK**

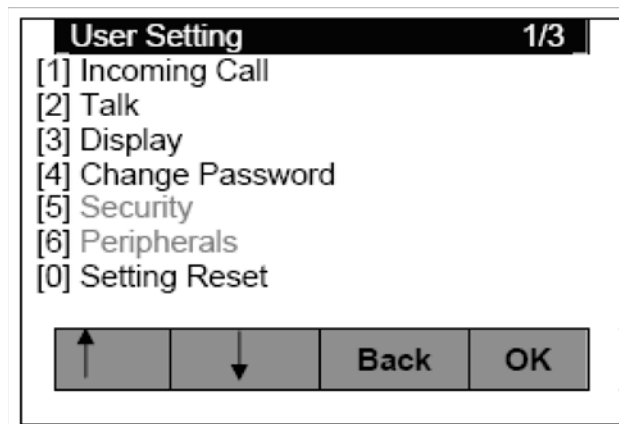

- Using Up/Down arrows scroll down to [4]
- Press [4] for change password, then **OK**

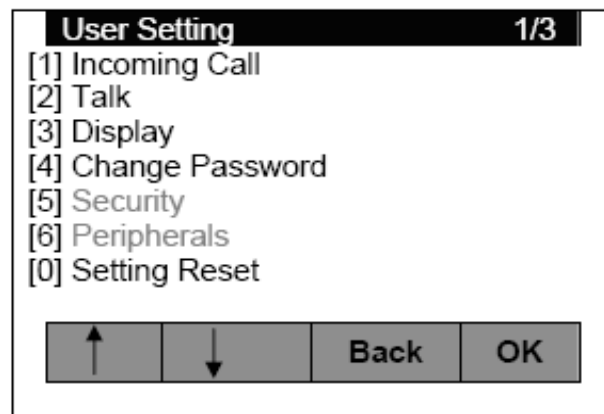

- Enter default password 0000
- Press **Set**, then enter **New Password**
- Press **Set**, then enter the new password again
- Press **Set**

- Press **OK**
- Display reads:

- Press **OK**
- Press **Back** three times to exit menu option

## Directory Operation

*This allows the user to access and program station speed dials*

- Press **Menu** key
- Display reads:

- Press **[2]** for Directory

*Programming of station speed dial memory is required in the PBX. Access/operation is the same.*

## History Operation

- Press **HIST** (History) Soft Key

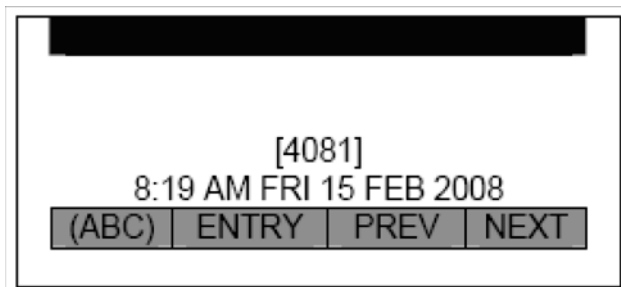

- Display reads:

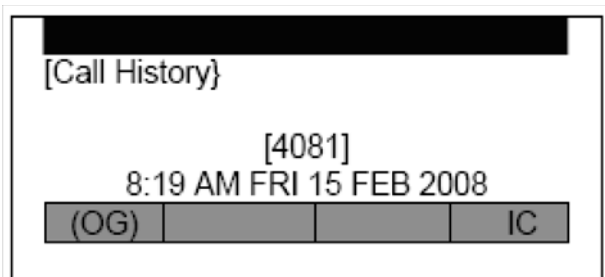

- Press **OG** (to view Outgoing calls) or press **IC** (to view Incoming calls)

*Programming is required in the PBX.*

## Quick Reference Guide

Outside Line		9
Queuing-Outside Line Call Back	Set Cancel	* 1 # 1
Call Forwarding-All Calls	Entry Cancel	* 5 # 5
Call Forwarding-No Answer/Busy Line	Entry Cancel	* 6 # 6
Call Forwarding-Destination	Entry Cancel	* 7 # 7
Do Not Disturb	Set Cancel	* 8 # 8
Last Number Redial		**
Account Code	Entry	* #
Station Speed Dialing	Originate	# *
System Speed Dialing	Originate	# #
Operator Call		0
Call Hold		11

Internal Zone Paging Group 0 Group 1 Group 2 Group 3 Group 4	Page	50 51 52 53 54
Internal Zone Paging Group 0 Group 1 Group 2 Group 3 Group 4	Answer	55 56 57 58 59
Time Reminder/Automatic Wake up	Set Cancel	5 * 5 #
Voice/Tone Toggle Station Name Assignment		60 62
Call Park System Retrieve Call Park System Set		6 # 6 *
Night Pickup		72
Call Pickup-Direct		73
Call Pickup-Group		74
Call Pickup-Designated	Group	75
Station Speed Dialing	Entry Cancel	7 * 7 #

**Note:** Above table references factory default settings. Settings may vary on a per system basis.





# NEC

NEC UNIFIED SOLUTIONS, INC.

NEC Unified Solutions, Inc.  
6535 N. State Highway 161  
Irving, TX 75039-2402

<http://www.necunified.com>